

GUESS

INSTRUCTION MANUAL
GUESS WATCHES ■

G U E S S

■ **WOMENS**



**Congratulations on owning your new GUESS Watch.
Developed from advanced electronics technology, the
movement is manufactured from the best quality components
and powered by a long life battery.**

HIGH PERFORMANCE FEATURES

▼ **30 METERS (3 ATM) TO 100 METERS (10 ATM)**

For style with 10 ATM, suitable for swimming, sailing, sail boarding, surfing & shallow diving.

▼ **WATER RESISTANT GENUINE LEATHER BANDS**

Specially developed water resistant leathers and construction are used in all GUESS straps.

▼ **HIGH QUALITY STAINLESS STEEL CASE & BRACELET**

OPERATING INSTRUCTIONS

SIMPLE TIME / MINI SWEEP / DUAL TIME

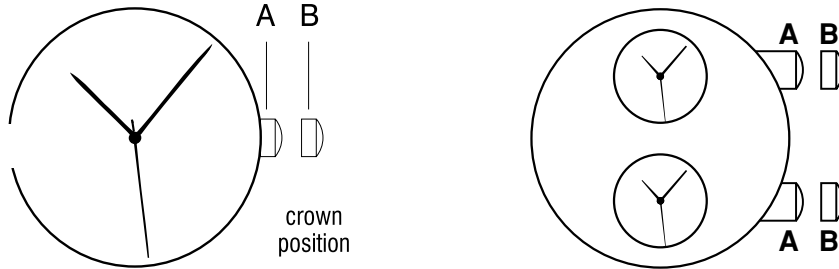

To set the time:

1. PULL out crown to B position.
2. TURN crown either way to correct time.
3. Push in crown to A position.

CALENDAR / DATE

To set the time:

1. PULL out Crown to C position.
2. TURN crown either way to correct time.
3. PUSH in crown to A position.

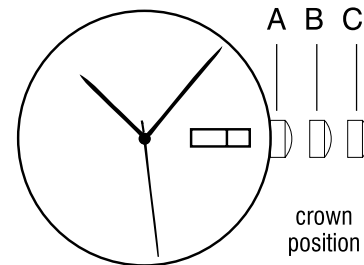

To set the calendar / date:

1. PULL out crown to B position.
2. TURN crown counter clockwise or towards you to correct date.
3. PUSH in crown to A position.

NOTE: The date changes automatically every 24 hours.

DAY / DATE / 24 HOUR

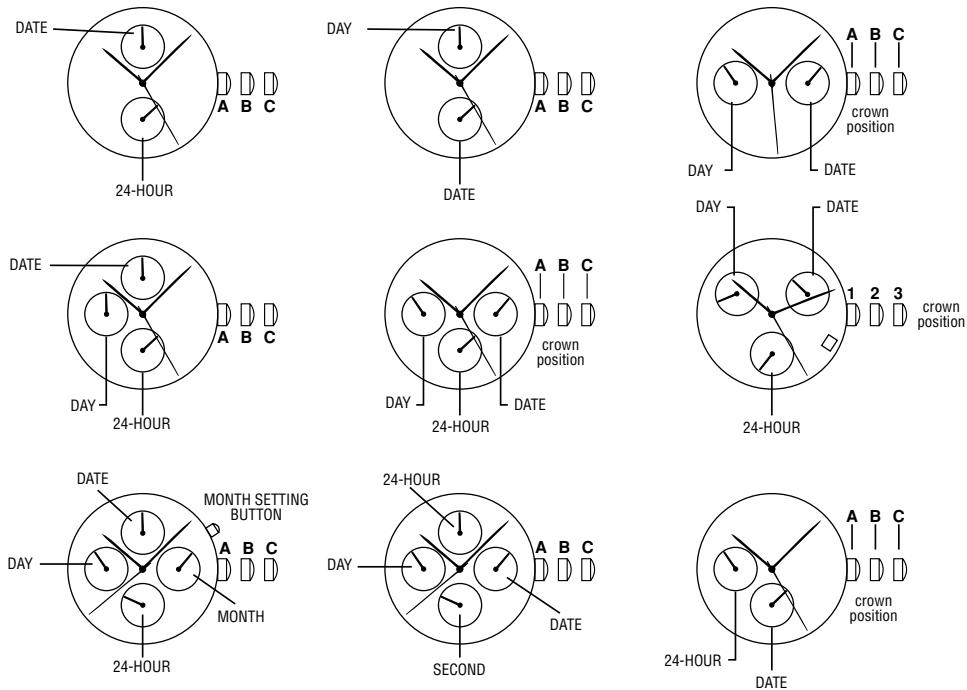

To set time:

1. PULL out crown to C position.
2. TURN crown either way to correct time.
3. PUSH in crown to A position.

To set date:

NOTE the date changes automatically every 24 hours.

1. PULL out crown to B position.
2. TURN crown clockwise to correct date.
3. PUSH in crown to A position.

To set day:

1. PULL out crown to C position.
2. Advance time 24 hours to change the day.
3. PUSH in crown to A position.

NOTE: 24 hour indicator can change only when setting the time.

To set month:

Push month setting button until the small hand of month is set to the correct month.

DAY / DATE / 24 HOUR

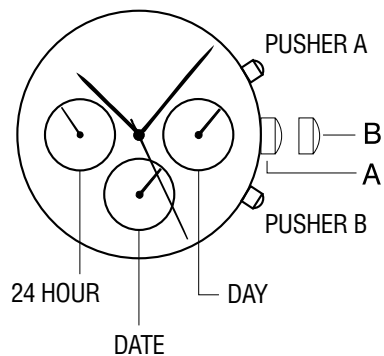

To set time:

1. PULL out crown to "B" position.
2. TURN crown either way to correct time.
3. PUSH in crown to "A" position

To set date:

DO NOT reset Date between 9:00 p.m. & 4:00 a.m. This may result in damaging the inner workings of the watch.

Note: the date changes automatically every 24 hours

1. Push Pusher "B" to correct date.

To set day:

1. Push Pusher "A" to correct day.

6,9,12 Three-eye Chronograph with Date

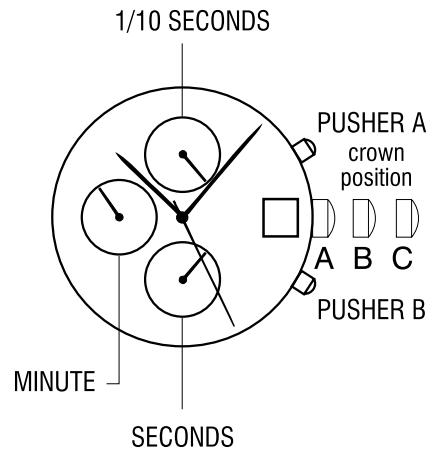

Crown position "A", "B" & "C".
 Pushers "A" (top) & "B" (bottom).
 12 o'clock eye "1/10 seconds elapsed".
 9 o'clock eye "minutes elapsed".
 6 o'clock eye "seconds elapsed".

This chronograph watch has 3 functions:
 TIME, CALENDAR, STOPWATCH.

TIME

To set the time:

1. PULL crown to "C" position.
2. TURN crown either way to correct time.
3. PUSH crown into "A" position.



CALENDAR

To set the calendar:

1. PULL out crown to “B” position.
2. TURN crown clockwise to correct date.
3. PUSH in crown to “A” position.

NOTE: The date changes automatically every 24 hours.

STOPWATCH

The stopwatch is capable of measuring:

1/10 seconds elapsed up to one second (top eye).

Minutes elapsed up to one hour (middle eye).

Seconds elapsed up to one minute (bottom eye)

BEFORE USING THE STOP WATCH, reset the stopwatch hands to the “60” and “0” positions.

To reset stopwatch hands:

1. PULL crown to position “C”.
2. PRESS pusher “A” intermittently until the top eye hand is reset to “0”.
3. PRESS pusher “B” intermittently until the middle and top eye hands is reset to “60”.

NOTE: PRESSING and HOLDING either pusher “A” or “B” will cause the hands to continue to move until the pusher is released.

If the stopwatch hands move improperly:

1. PULL out the crown to “B” position.
2. PRESS pushers “A” & “B” simultaneously for three seconds.
3. RELEASE pushers, stopwatch hands will move 180 degrees.
4. PUSH crown in to “A” position.



Standard stopwatch measurement:

1. PRESS pusher "A" to start timing.
2. PRESS pusher "A" to stop timing.
3. PRESS pusher "B" to reset.

Timing 2 competitors:

1. PRESS pusher "A" to start timing.
2. PRESS pusher "B" to stop timing.
3. PRESS pusher "A" to stop timing of second event.
4. PRESS pusher "B" to view time of second event.
5. PRESS pusher "B" to reset.

Split time:

1. PRESS pusher "A" to start timing.
2. PRESS pusher "B" to split.
3. PRESS pusher "B" to begin again.
4. PRESS pusher "A" to stop.
5. PRESS pusher "B" to reset.

6,12 TWO-EYE CHRONOGRAPH WITH DATE

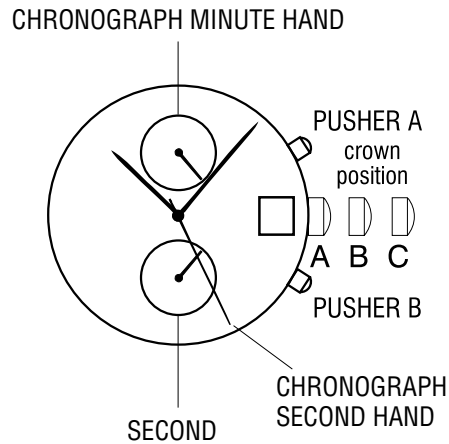

Crown position "A", "B" & "C".
 Pushers "A" (top) & "B" (bottom).
 12 o'clock eye "1 minute up to maximum 60 minute".
 6 o'clock eye "second".

This chronograph watch has 3 functions:
 TIME, CALENDAR, STOPWATCH.

TIME

To set the time:

1. PULL crown to "C" position.
2. TURN crown either way to correct time.
3. PUSH crown in to "A" position, small second hand begins to run.



CALENDAR

To set the calendar:

1. PULL out crown to “B” position.
2. TURN crown clockwise to correct date.
3. PUSH in crown to “A” position.

NOTE: The date changes automatically every 24 hours.

STOPWATCH

The stopwatch is capable of measuring:

1/1 second elapsed up to maximum of 60 minute (top eye).

BEFORE USING THE STOP WATCH, reset the stopwatch hands to the “60” and “0” positions.

To reset stopwatch hands:

1. PULL crown to position “C”.
2. PRESS pusher “A” intermittently until the chronograph second hand is reset to “0”.

Standard stopwatch measurement:

1. PRESS pusher “A” to start timing.
2. PRESS pusher “A” to stop timing.
3. PRESS pusher “B” to reset.

Accumulated elapsed time measurement:

1. PRESS Pusher “A” to start timing.
2. PRESS Pusher “A” to stop timing.
3. PRESS pusher “A” to restart timing.
4. PRESS Pusher “A” to stop 2nd timing.
5. PRESS Pusher “B” to reset.

ANA-DIGIT



FEATURES

Hour, Minute, Second
 Month, Date
 Back Light (EL)

NORMAL TIME MODE

1. PRESS S1 once to view Month & Date
2. PRESS S1 twice to view Second
3. PRESS S2 once, ""Time"" & ""Date"" mode will be displayed alternatively
 PRESS S1 twice, back to Time mode"
4. PRESS EL to light-up display

SETTING SEQUENCE

1. PRESS S2 twice to set "Month"; Press S1 to advance
2. PRESS S2 once to set "Date"; Press S1 to advance
3. PRESS S2 once to set "Hour"; Press S1 to advance
4. PRESS S2 once to set "Minute"; Press S1 to advance
5. PRESS S2 once when setting is complete. Normal time will be displayed
 (Press S1 if time mode does not flash).

G U E S S

■ MENS



**Congratulations on owning your new GUESS Watch.
Developed from advanced electronics technology, the
movement is manufactured from the best quality components
and powered by a long life battery.**

HIGH PERFORMANCE FEATURES

▼ **30 METERS (3 ATM) TO 100 METERS (10 ATM)**

For style with 10 ATM, suitable for swimming, sailing, sail boarding, surfing & shallow diving.

▼ **WATER RESISTANT GENUINE LEATHER BANDS**

Specially developed water resistant leathers and construction are used in all GUESS straps.

▼ **HIGH QUALITY STAINLESS STEEL CASE & BRACELET**

▼ **MINERAL CRYSTALS**

All GUESS watches are manufactured with mineral crystals for increased water and scratch resistance, as well as greater durability.

OPERATING INSTRUCTIONS

SIMPLE TIME / MINI SWEEP / DUAL TIME

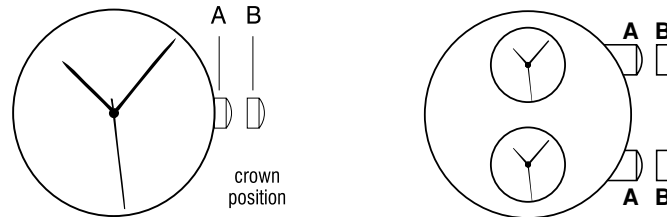

To set the time:

1. PULL out crown to B position.
2. TURN crown either way to correct time.
3. Push in crown to A position.

CALENDAR / DATE

To set the time:

1. PULL out Crown to C position.
2. TURN crown either way to correct time.
3. PUSH in crown to A position.

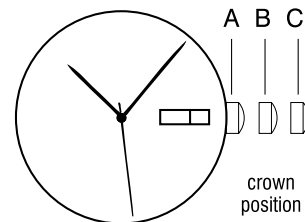

To set the calendar / date:

1. PULL out crown to B position.
2. TURN crown counter clockwise or towards you to correct date.
3. PUSH in crown to A position.

NOTE: The date changes automatically every 24 hours.

DAY / DATE / 24 HOUR

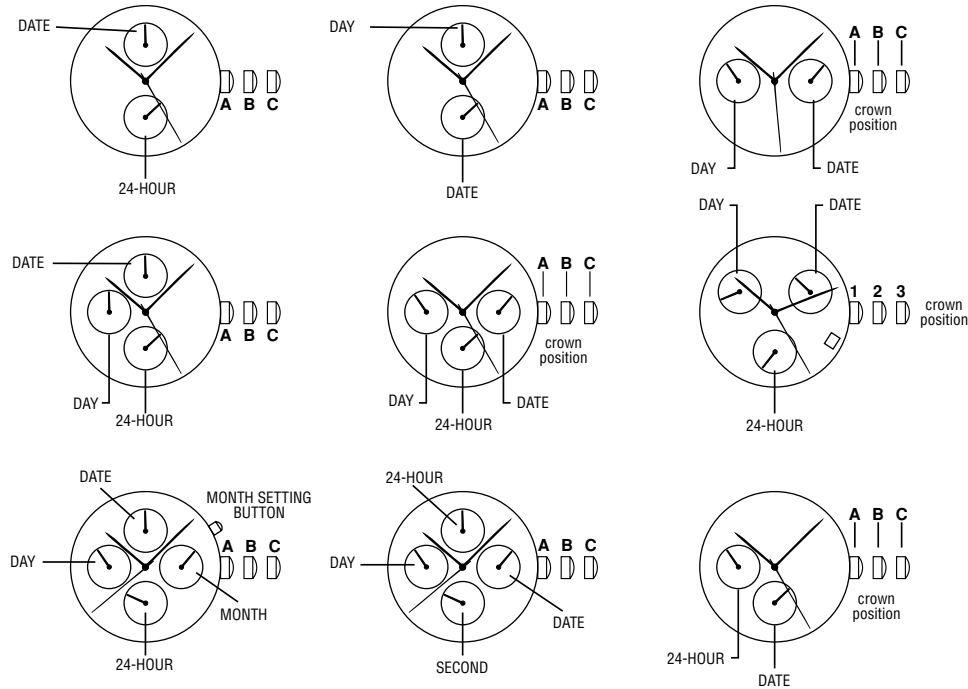

To set time:

1. PULL out crown to C position.
2. TURN crown either way to correct time.
3. PUSH in crown to A position.

To set date:

NOTE the date changes automatically every 24 hours.

1. PULL out crown to B position.
2. TURN crown clockwise to correct date.
3. PUSH in crown to A position.

To set day:

1. PULL out crown to C position.
2. Advance time 24 hours to change the day.
3. PUSH in crown to A position.

NOTE: 24 hour indicator can change only when setting the time.

To set month:

Push month setting button until the small hand of month is set to the correct month.

DATE / 24 HOUR

To set the time:

1. PULL out Crown to C position.
2. TURN Crown either way to correct time.
3. PUSH in Crown to A position.

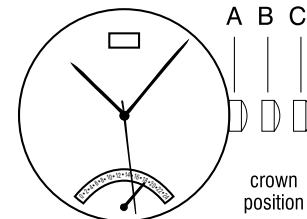

To set the 24 hour indicator:

1. PULL out Crown to B position.
2. TURN Crown counter-clockwise to correct time.
3. PUSH in Crown to A position.

To set the date:

1. PULL out Crown to B position.
2. TURN Crown clockwise to correct date.
3. PUSH in Crown to A position.

DAY / DATE / 24 HOUR

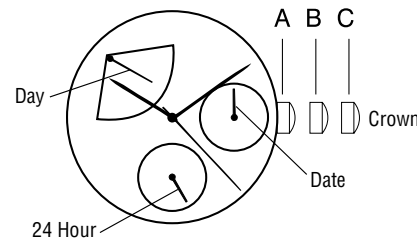
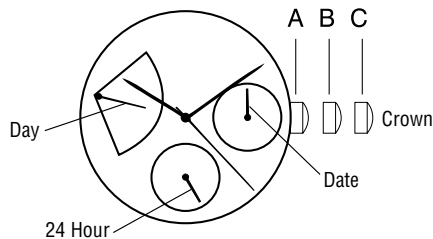

To set the time:

1. PULL out Crown to C position.
2. TURN Crown clockwise/counter-clockwise to correct t
3. PUSH in Crown to A position.

To set the day:

1. PULL out Crown to C position.
2. Advance time 24 hours to change the day.
3. PUSH in Crown to A position.

To set the date:

1. PULL out Crown to B position.
2. TURN Crown counter-clockwise to correct date.
3. PUSH in Crown to A position.

Note: 24 Hour indicator changes automatically when time is adjusted.

THE THREE EYE CHRONOGRAPH

This chronograph watch has 2 functions:

TIME, STOPWATCH.

The left eye (stopwatch hand) measures minutes elapsed on stopwatch, up to a maximum of 60 minutes.

The centre eye (stopwatch hand) measures seconds elapsed on stopwatch, up to a maximum of 60 seconds. It also shows measurement of elapsed time.

The right eye (24 hour hand) indicates time on a 24 hour basis.

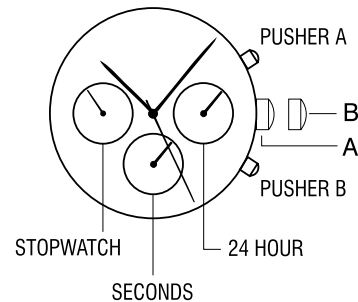

TIME

To set time:

1. PULL out crown to B position
2. TURN crown either way to correct time
3. PUSH crown to A position

NOTE: If eye indicating 24 hours needs adjustment, advance watch hands by 12 hours.

STOPWATCH:

The stopwatch can measure up to 1 hour in minutes and seconds. Before using the stopwatch ensure that stopwatch hands are at the '60' or '12 o'clock' position.

To adjust hands:

1. PULL out Crown to B positions.
2. PRESS pusher A or B to adjust hands.
3. PUSH Crown to A position.

To set stopwatch:

1. PRESS pusher A to start timing.
2. PRESS pusher A to stop timing.
3. PRESS pusher B to reset stopwatch to '60'.

To measure elapsed or split time:

1. PRESS pusher A to start timing.
 2. PRESS pusher B to stop timing. The stopwatch continues to count seconds elapsed but the hands do not move.
 3. PRESS pusher B again to resume timing. The hands move quickly to indicate elapsed time and continue counting.
- NOTE: The hour, minute and second hands on the watch will continue to indicate the correct time while using the stopwatch.

If stopwatch hands do not return to "60" when the stopwatch is reset:

1. PULL out the crown.
2. PRESS pushers A or B repeatedly to move hands to "60" position.
3. PUSH in the crown.

6,9,12 THREE-EYE CHRONOGRAPH WITH & WITHOUT DATE

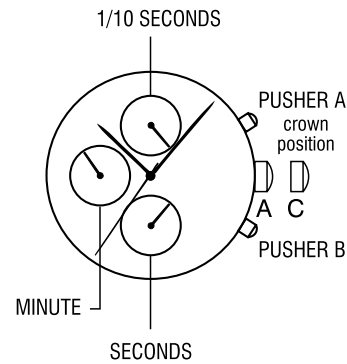
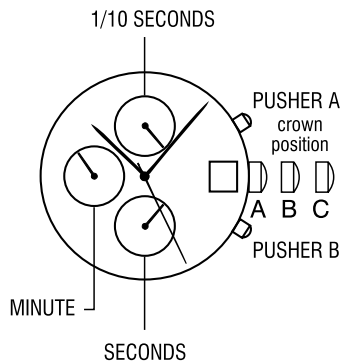

Crown position "A", "B" & "C".
 Pushers "A" (top) & "B" (bottom)
 12 o'clock eye "1/10 seconds elapsed"
 9 o'clock eye "minutes elapsed"
 6 o'clock eye "seconds elapsed"

This chronograph watch has 3 functions:

TIME, CALENDAR, STOPWATCH

TIME

To set the time:

1. PULL Crown to "C" position.
2. TURN Crown either way to correct time.
3. PUSH Crown into "A" position.

CALENDAR

To set the calendar:

1. PULL out Crown to "B" position.
2. TURN Crown clockwise to correct date.
3. PUSH in Crown to "A" position.

NOTE: The date changes automatically every 24 hours.

STOPWATCH

The stopwatch is capable of measuring:

1/10 seconds elapsed up to one second (top eye).
 Minutes elapsed up to one hour (middle eye).
 Seconds elapsed up to one minute (bottom eye)

BEFORE USING THE STOP WATCH, reset the stopwatch hands to the "60" and "0" positions.

2,6,10 THREE-EYE CHRONOGRAPH

NOTE: Crown position “1”, “2” & “3”

NOTE: Pushers “A” (top) & “B” (bottom)

NOTE: Left eye “minute totalizer”

NOTE: Right eye “small second”

NOTE: Centre eye “date indicator”

This chronograph watch has 3 functions:

TIME, CALENDAR, STOPWATCH

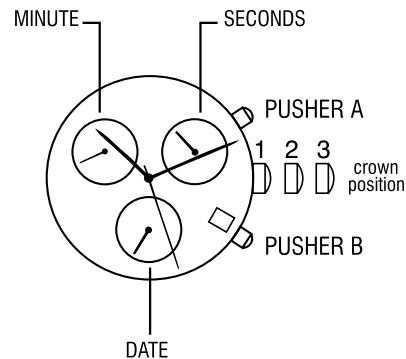

TIME

To set the time:

1. PULL Crown to position “3” .
2. TURN Crown either way to correct time.
3. PUSH Crown to position “1” .

CALENDAR

To set the calendar:

1. PULL Crown to position “2” .
2. TURN Crown clockwise to correct the date.
3. PUSH in Crown to position “1” .

STOPWATCH

The stopwatch is capable of measuring:

1. Minutes elapsed up to 30 minutes (left eye).
2. Chronograph hand 1/5 second

BEFORE USING THE STOPWATCH, reset the stopwatch hands to the “60” position by mean of pusher “B”. If stopwatch Hands move improperly, reset the hands as follow:

To reset stopwatch hands:

1. PRESS Pusher “A” & “B”.
2. PRESS Pusher “B” intermittently until the left eye hand is reset to “0”.
3. PRESS Pusher “A” intermittently until the chronograph hand reset to “60”.
4. PRESS Pusher “A” & “B”.



NOTE: PRESSING and HOLDING either Pusher “A” or “B” will cause the hands to continue to move until the pusher is released.

Standard stopwatch measurement:

1. PRESS Pusher “A” to start timing.
2. PRESS Pusher “A” to stop timing.
3. PRESS Pusher “B” to reset.

Accumulated elapsed time measurement:

1. PRESS Pusher “A” to start timing.
2. PRESS Pusher “A” to stop timing.
3. PRESS Pusher “A” to restart timing.
4. PRESS Pusher “A” to stop 2nd timing.
5. PRESS Pusher “B” to reset.

Split time measurement:

1. PRESS Pusher “A” to start timing.
2. PRESS Pusher “B” to split.
3. PRESS Pusher “B” to begin again.
4. PRESS Pusher “A” to stop.
5. PRESS Pusher “B” to reset.

Timing 2 competitors:

1. PRESS Pusher “A” to start timing of first event.
2. PRESS Pusher “B” to stop timing of first event. Stopwatch continues to run internally.
3. PRESS Pusher “A” to stop timing of second event.
4. PRESS Pusher “B” to view time of second event.
5. PRESS Pusher “B” to reset.

6,12 TWO-EYE CHRONOGRAPH WITH DATE

Crown position "A", "B" & "C".

Pushers "A" (top) & "B" (bottom).

6 o'clock eye "1 minute up to maximum 60 minute".

12 o'clock eye "second".

This chronograph watch has 3 functions:

TIME, CALENDAR, STOPWATCH.

TIME

To set the time:

1. PULL Crown to "C" position.
2. TURN Crown either way to correct time.
3. PUSH Crown in to "A" position, small second hand begins to run.

CALENDAR

To set the calendar:

1. PULL out Crown to "B" position.
2. TURN Crown clockwise to correct date.
3. PUSH in Crown to "A" position.

NOTE: The date changes automatically every 24 hours.

STOPWATCH

The stopwatch is capable of measuring:

1/1 second elapsed up to 12 hours.

BEFORE USING THE STOP WATCH, reset the stopwatch hands to the "0" positions.

To reset stopwatch hands:

1. PULL Crown to position "C".
2. PRESS Pusher "A" intermittently until the chronograph second hand is reset to "0".

Standard stopwatch measurement:

1. PRESS Pusher "A" to start timing.
2. PRESS Pusher "A" to stop timing.
3. PRESS Pusher "B" to reset.

Accumulated elapsed time measurement:

1. PRESS Pusher "A" to start timing.
2. PRESS Pusher "A" to stop timing.
3. PRESS Pusher "A" to restart timing.
4. PRESS Pusher "A" to stop 2nd timing.
5. PRESS Pusher "B" to reset.

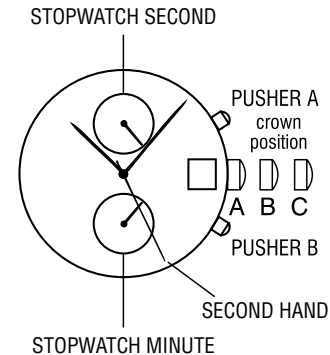

3,6,9,12 FOUR-EYE CHRONOGRAPH

NOTE: Crown position "A" & "B"

NOTE: Pushers "A" (top) & "B" (bottom)

NOTE: 12 o'clock eye "1/10" or seconds elapsed"

NOTE: 9 o'clock eye "minutes elapsed"

NOTE: 6 o'clock eye "seconds elapsed"

NOTE: 3 o'clock eye "24-hour"

This chronograph watch has 2 functions:

TIME, STOPWATCH.

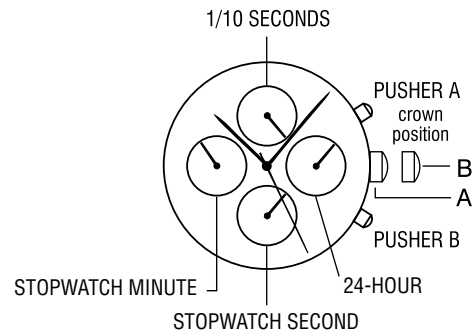

TIME

To set the time:

1. PULL Crown to "B" position.
2. TURN Crown either way to correct time.
3. PUSH Crown in to "A" position.

STOPWATCH

The stopwatch is capable of measuring:

1/10 seconds elapsed up to 60 minutes (top eye).

Minutes elapsed up to one hour (middle eye).

Seconds elapsed up to one minute (bottom eye)

BEFORE USING THE STOPWATCH, reset the stopwatch hands to the "60" and "0" positions.

**To reset stopwatch hands:**

1. PULL Crown to position “B”.
2. PRESS Pusher “A” intermittently until the top eye hand is reset to “0”.
3. PRESS Pusher “B” intermittently until the minute and second eye hands reset to “60”.

NOTE: PRESSING and HOLDING either Pusher “A” or “B” will cause the hands to continue to move until the pusher is released.

Standard stopwatch measurement:

1. PRESS Pusher “A” to start timing.
2. PRESS Pusher “A” to stop timing.
3. PRESS Pusher “B” to reset.

Accumulated elapsed time measurement:

1. PRESS Pusher “A” to start timing.
2. PRESS Pusher “A” to stop timing.
3. PRESS Pusher “A” to restart timing.
4. PRESS Pusher “A” to stop 2nd timing.
5. PRESS Pusher “B” to reset.

Split time measurement:

1. PRESS Pusher “A” to start timing.
2. PRESS Pusher “B” to stop split.
3. PRESS Pusher “B” to begin again.
4. PRESS Pusher “A” to stop.
5. PRESS Pusher “B” to reset.

3,6,9, THREE-EYE CHRONOGRAPH WITH DATE

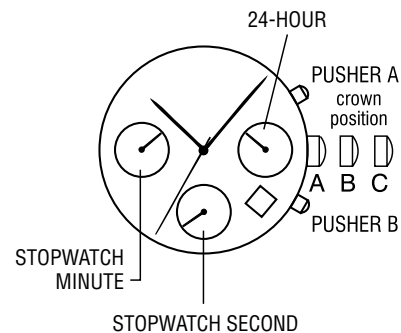
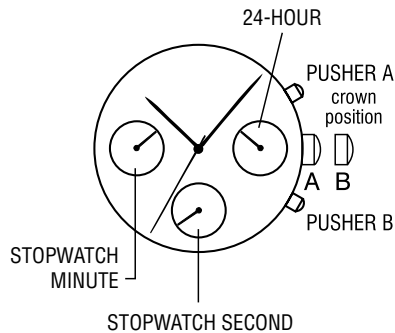

Crown position "A", "B" & "C".
 Pushers "A" (top) & "B" (bottom).
 3 o'clock eye "24-hour".
 9 o'clock eye "minutes elapsed".
 6 o'clock eye "seconds elapsed".

This chronograph watch has 2 functions:

TIME, STOPWATCH.

TIME

To set the time:

1. PULL Crown to "B" position.
2. TURN Crown either way to correct time.
3. PUSH Crown in to "A" position.

CALENDAR

To set the calendar:

1. PULL out Crown to "B" position.
2. TURN Crown clockwise to correct date.
3. PUSH in Crown to "A" position.

NOTE: The date changes automatically every 24 hours.



STOPWATCH

The stopwatch is capable of measuring:

Minutes elapsed up to one hour (left eye).

Seconds elapsed up to one minute (bottom eye)

BEFORE USING THE STOP WATCH, reset the stopwatch hands to the “60” and “12 o'clock” positions.

To reset stopwatch hands:

1. PULL Crown to position “B”.
2. PRESS Pusher “A” or “B” intermittently until the stopwatch minute and second hand is reset to “0”.

NOTE: By pressing Pusher “A”, the hands move counter clockwise. By pressing Pusher “B”, the hands move clockwise.

Standard stopwatch measurement:

1. PRESS Pusher “A” to start timing.
2. PRESS Pusher “A” to stop timing.
3. PRESS Pusher “B” to reset.

Split time:

1. PRESS Pusher “A” to start timing.
2. PRESS Pusher “B” to stop split.
3. PRESS Pusher “B” to begin again.
4. PRESS Pusher “A” to stop.
5. PRESS Pusher “B” to reset.

Accumulated elapsed time measurement:

1. PRESS Pusher “A” to start timing.
2. PRESS Pusher “A” to stop timing.
3. PRESS Pusher “A” to restart timing.
4. PRESS Pusher “A” to stop 2nd timing.
5. PRESS Pusher “B” to reset.

6, 9, 12 THREE EYE 1/20 SECOND CHRONOGRAPH WITH DATE

Crown position "A", "B" & "C".
 Pushers "A" (top) & "B" (bottom).
 6 o'clock eye "hour & minutes elapsed".
 9 o'clock eye "second".
 12 o'clock eye "1/20 seconds elapsed".

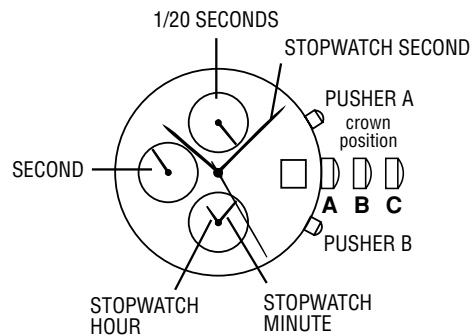

This chronograph watch has 3 functions:
 TIME, STOPWATCH, CALENDAR.

TIME

To set the time:

1. PULL Crown to "C" position.
2. TURN Crown either way to correct time.
3. PUSH Crown in to "A" position.

CALENDAR

To set the calendar:

1. PULL out Crown to "B" position.
2. TURN Crown clockwise to correct date.
3. PUSH in Crown to "A" position.

NOTE: The date changes automatically every 24 hours.
 Do not set the date between 9:00 PM and 1:00 AM.

STOPWATCH

The stopwatch is capable of measuring:

Hour & Minutes elapsed up to 12 hours (bottom eye).
 1/20 Seconds elapsed up to 12 hours (top eye).
 Seconds elapsed up to 12 hours.

BEFORE USING THE STOP WATCH, reset the stopwatch hands to the "60" and "12 o'clock" positions.

To reset stopwatch hands:

1. PULL Crown to position "C".
2. PRESS Pusher "A" for 2 seconds until the stopwatch hour, minute and second hand is reset to "0".

**Standard stopwatch measurement:**

1. PRESS Pusher "A" to start timing.
2. PRESS Pusher "A" to stop timing.
3. PRESS Pusher "B" to reset.

Split time:

1. PRESS Pusher "A" to start timing.
2. PRESS Pusher "B" to stop split.
3. PRESS Pusher "B" to begin again.
4. PRESS Pusher "A" to stop.
5. PRESS Pusher "B" to reset.

Accumulated elapsed time measurement:

1. PRESS Pusher "A" to start timing.
2. PRESS Pusher "A" to stop timing.
3. PRESS Pusher "A" to restart timing.
4. PRESS Pusher "A" to stop 2nd timing.
5. PRESS Pusher "B" to reset.

Timing 2 competitors:

1. PRESS pusher "A" to start timing.
2. PRESS pusher "B" to stop timing of first event. Stopwatch continues to run internally.
3. PRESS pusher "A" to stop timing of second event.
4. PRESS pusher "B" to view time of second event.
5. PRESS pusher "B" to reset.

DIGITAL WITH ALARM / DUAL TIME / CHRONOGRAPH



FEATURES

Hour, Minute, Second

Day, Date, Month

Dual Time, Alarm, Timer

Chronograph 1/100 Second with Split Back Light (EL)

OPERATION MODES

1. PRESS S3 once to view Time, Day, Date, Month
2. PRESS S3 once to view Alarm
3. PRESS S3 once to view Chrono
5. PRESS S3 once to set Timer
6. PRESS S3 again back to Time mode

SETTING SEQUENCE

A) NORMAL TIME SETTING .

1. HOLD S2 2 seconds to set "Second"; Press S1 for 00
2. PRESS S3 once to set "Minute"; Press S1 to advance
3. PRESS S3 once to set "Hour"; Press S1 to advance
4. PRESS S3 once to set hour display; Press S1 to set "12H" / "24H"
5. PRESS S3 once to set "Month"; Press S1 to advance
6. PRESS S3 once to set "Date"; Press S1 to advance
7. PRESS S3 once to set "Day"; Press S1 to advance
8. PRESS S2 once when setting is complete. Normal time will be displayed.

B) DUAL TIME SETTING .

1. PRESS S1 to Dual Time
2. HOLD S2 2 seconds to set "Minute"; Press S1 for 00
3. PRESS S3 once to set "Hour"; Press S1 to advance
4. PRESS S2 once when setting is complete. Normal time will be displayed.



C) ALARM SETTING

PRESS S3 to Alarm Mode

1. PRESS S1 once to on "Alarm" ONLY
2. PRESS S1 once to on "Chime" ONLY
3. PRESS S1 once to on "Alarm" & "Chime"
4. PRESS S1 once to off "Alarm" & "Chime"
5. HOLD S2 2 seconds to set "Hour"; Press S1 to advance
6. PRESS S3 once to set "Minute"; Press S1 to advance
7. PRESS S2 once when setting is complete. Return to Alarm Mode.

D) CHRONOGRAPH

PRESS S3 twice to Chronograph function

1. PRESS S1 to "Start" / "Stop" timing
2. PRESS S2 to "Split" time
3. PRESS S1, then S2 to "Reset"

E) TIMER

PRESS S3 three times to Time Mode

1. HOLD S2 2 seconds to set "Hour"; Press S1 to advance
2. PRESS S3 once to set "Minute"; Press S1 to advance
3. PRESS S2 once when setting is complete.
4. PRESS S1 to "Start" / "Stop"
5. PRESS S2 to "Reset"

When counting complete, alarm will sound.

ANA-DIGIT



FEATURES

Hour, Minute, Second
 Month, Date
 Back Light (EL)

NORMAL TIME MODE

1. PRESS S1 once to view Month & Date
2. PRESS S1 twice to view Second
3. PRESS S2 once, "Time" & "Date" mode will be displayed alternatively
 PRESS S1 twice, back to Time mode"
4. PRESS EL to light-up display

SETTING SEQUENCE

1. PRESS S2 twice to set "Month"; Press S1 to advance
2. PRESS S2 once to set "Date"; Press S1 to advance
3. PRESS S2 once to set "Hour"; Press S1 to advance
4. PRESS S2 once to set "Minute"; Press S1 to advance
5. PRESS S2 once when setting is complete. Normal time will be displayed (Press S1 if time mode does not flash).

DIGITAL WITH ALARM, CHRONOGRAPH 1/100 SEC, COUNTDOWN & DUAL TIME

FEATURES

Hour, Minute, Second
Day, Date, Month
Dual Time, Alarm, Countdown
Chronograph 1/100 Second with lap control
Back Light (EL)



SETTING SEQUENCE

A) NORMAL TIME SETTING

1. HOLD S2 3 seconds to "Second"; Press S1 or S3 for 00
2. PRESS S2 once to set "Minute"; Press S1 or S3 to advance / backward
3. PRESS S2 once to set "Hour"; Press S1 or S3 to advance / backward
4. PRESS S2 once to set "Year"; Press S1 or S3 to advance / backward
5. PRESS S2 once to set "Month"; Press S1 or S3 to advance / backward
6. PRESS S2 once to set "Day"; Press S1 or S3 to advance / backward
7. HOLD S2 3 seconds to return to normal time display.

B) DUAL TIME SETTING

1. PRESS S1 to Dual Time
2. HOLD S2 2 seconds to set "Minute"; Press S1 for 00
3. PRESS S3 once to set "Hour"; Press S1 to advance
4. PRESS S2 once when setting is complete. Normal time will be displayed.

C) ALARM SETTING

PRESS S3 to Alarm Mode

1. PRESS S1 to "Alarm 1" – "Alarm 5"
2. HOLD S2 2 seconds until "AL" flash
PRESS S1/S3 to set "Alarm" / "Chime"
3. PRESS S2 once to set "Hour" Press S1 or S3 to advance / backward
4. PRESS S2 once to set "Minute" Press S1 or S3 to advance / backward
5. HOLD S2 3 seconds when setting is complete. Return to Alarm Model.



D) COUNTDOWN TIMER SETTING

- (i) PRESS S3 twice to Countdown Timer function [T1] (1~90 mins)
 - 1) HOLD S2 2 seconds to set "Minute"; Press S1/S3 to advance / backward
 - 2) HOLD S2 3 sec to end setting
 - 3) PRESS S2 to start/stop countdown

- (ii) PRESS S1 to get into Countdown timer [T2] (from normal time to preset time – within 24hrs)
 - 1) HOLD S2 3 seconds to set "Hour"; Press S1/S3 to advance / backward
 - 2) PRESS S2 once to set "Minute" Press S1 or S3 to advance / backward
 - 3) HOLD S2 3 sec to end setting
 - 4) PRESS S2 to start/stop countdown. Time different between Normal time & Preset time will be shown

- (iii) PRESS S1 to get into Countdown Day Timer [T3]
 - 1) HOLD S2 3 seconds to set "Year"; Press S1/S3 to advance / backward
 - 2) PRESS S2 once to set "Month" Press S1 or S3 to advance / backward
 - 3) PRESS S2 once to set "Day" Press S1 or S3 to advance / backward
 - 4) PRESS S2 once when setting is complete.

E) CHRONOGRAPH

PRESS S3 three times to Chronograph Mode

- 1) PRESS S1 to select LAP (LAP) or Split (SPL) option
- 2) PRESS S2 to start/stop
- 3) PRESS S1 to get Lap/Split time
- 5) HOLD S2, then press S1 to "Reset"



LIMITED TWO YEAR CANADIAN WARRANTY

This GUESS Watch (but not any crystal, lens, band, strap, or if applicable, energy cell) is warranted to the owner for a period of TWO (2) YEARS from the date of original purchase against manufacturer's defects not by the dealer from whom the watch was purchased.

If this watch develops such a defect within the TWO YEAR period, it will be repaired or replaced at our option. We reserve the right to charge you for a replacement battery if the analog watch battery is depleted. No additional charge will be made for the repair unless the TWO YEAR warranty period has expired or servicing is necessary for reasons beyond our control, in which case a moderate charge will be made.

This warranty is void if the watch has been tampered with, taken apart by anyone other than our authorized service centre. The warranty does not cover water damage, unless the watch is marked "water resistant". We recommend that you do not get your leather strap wet.



LIMITED TWO YEAR CANADIAN WARRANTY

To service your watch, please send to the below address:

Sequel Canada Service Centre

240 Riviera Drive, Unit 1A

Markham, ON

L3R 5M1

sequelrepairsCanada@gmail.com

Tel: 1-877-31-GUESS

Fax: 1-905-948-8354

For faster service and prevent possible loss, we advise that you send your watch by insured mail. Never include a special watch band or any other article of personal value in your shipment.

For the most expedient repair of your watch we suggest that you send it back to the above address rather than taking back to the store.

If you have additional questions, please call CUSTOMER SERVICE at: 1-877-31-GUESS.



LIMITED TWO YEAR CANADIAN WARRANTY REPAIR COUPON

Please complete and return the following form with your carefully packaged watch for repair to the address below with proof of purchase. You will be contacted by the service centre to arrange payment for return shipping.

Sequel Canada Service Centre
240 Riviera Drive, Unit 1A
Markham, ON
L3R 5M1

sequelrepairsCanada@gmail.com
Tel: 1-877-31-GUESS
Fax: 1-905-948-8354

NAME

ADDRESS

CITY

PROVINCE

POSTAL CODE

PHONE #

DATE SENT

